



Essae[®]
...for Excellence

Corporate Profile

“Win-Win is a belief in the third alternative.

It’s not your way or my way;
it’s a better way, a higher way.”

- **Stephen Covey**

The Genesis of Essae

My innate nature is to seek knowledge, convert into wisdom and translate it into positive action to serve society by touching the lives of people. Having studied Mechanical Engineering and worked in two organisations, one a government research laboratory and another an academic institution, the emptiness continued. I changed four jobs in seven years since I wanted to explore the different aspects of life in different places and in different roles. I wanted to experiment my entrepreneurial acumen. I shifted my gear from seeking one more job to providing many more jobs. This is the genesis of Essae.

The one and only capital I had was a powerful idea coupled with indomitable courage and conviction to make my knowledge useful for me, my family and society at large. "The journey of thousand miles begins with a single step". The first step was taken in the right direction when my mother inaugurated "Essae" on 15 June 1965 along with the blessings of my father and brothers. The journey has not been easy, though challenging and inspiring. I could learn from every failure that kept me going for over 56 years without losing enthusiasm.

The purpose of any organisation is to serve society and also make profit as a by-product. The right values and robust systems are embedded in the veins of Essae since inception. I am sure, this momentum will continue to accelerate a healthy growth in the years to come.

I am grateful to those who have travelled along with me in this marathon. The journey continues to be wonderful and self-fulfilling. I wish Essae group to use this innate strength to grow to its full potential



With Love,

A handwritten signature in black ink, appearing to read 'Essae Chandran'.

Essae Chandran
Founder & Chairman- Emeritus

Global Partnerships

It is truly a flat world now. Essae realises the strong need to partner with global technology leaders to bring the best of products & solutions to the Indian customer.

The Teraoka/DIGI group was founded in 1936 with presence in over 75 countries and is the global leader in weighing & POS technology for retail & industrial markets. It has more than 76 years of rich history in setting new standards by offering innovative solutions such as the first price computing scale, automatic Weigh-Wrap-Labeller etc.

Essae-Teraoka was conceived as a manufacturing joint venture with Teraoka Seiko of Japan in 1986 with co-operation in the form of financial investment in equity and technology transfer. A large part of our success was due to our founder's vision to manufacture Teraoka/DIGI scales in India as early as 1987.



POS System



POS Scale

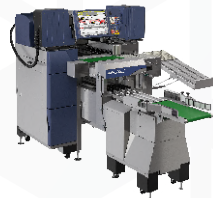

Weigh-Wrap-Labeller



Kazuharu Teraoka
Chairman, Digi/Teraoka Group
Director, Essae-Teraoka

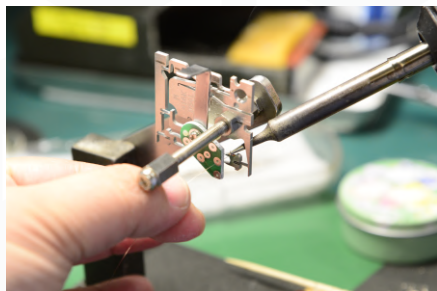

Shinko Denshi of Japan is the inventor and only manufacturer of the famed Vibra brand of high precision weighing balances using the tuning fork sensor. This technology is extremely reliable since it does not suffer from the common limitations such as temperature drift & complexity associated with other weighing technologies. Essae markets & supports Vibra's complete range of precision, analytical & semi-micro balances for the laboratory & jewellery markets.

Collaborating for Win-Win

Ethics & values in business come before everything else for Essae.

We work based on the deep rooted conviction that Win-Win is the only sustainable foundation for all successful long term partnerships with all our stakeholders. The business environment & technology is rapidly changing and disrupting both our customers and competitors alike. Such disruptions have always fuelled in us a burning passion and a deeper commitment to provide more relevant and innovative products and solutions to all our customers & business partners.

Competition here is truly global in nature with the best of technology & products made available to the Indian customer. Our sustained success for more than 35 years is substantial proof of our ability to compete and win against any global competition through long term investment on our people, R&D and excellence in manufacturing & quality.

Finally, the real strength of Essae is the deep commitment of our beloved Essae-ites towards this shared vision and mission.

with Best Wishes,



Prabhu Chandran
Managing Director



Our History

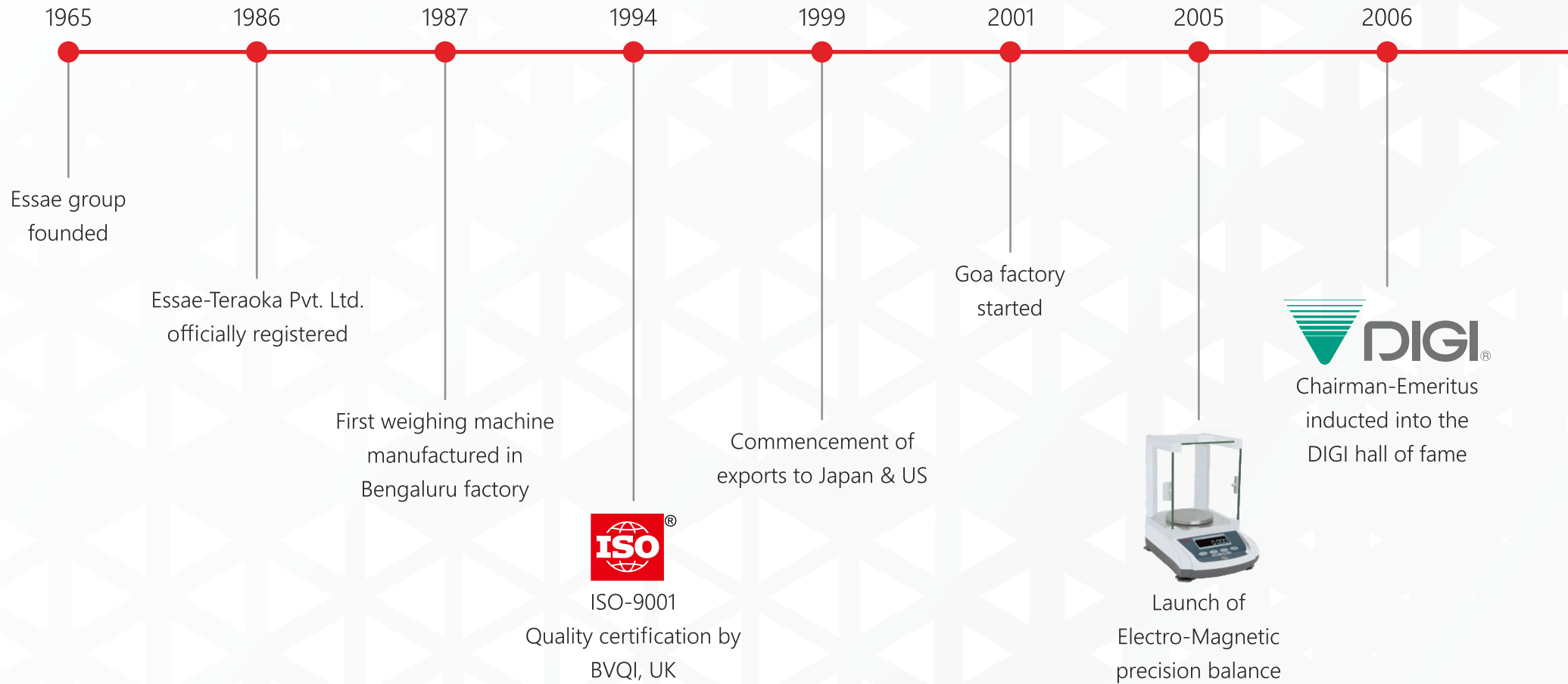

2008



Launch of India's first weighing system indicator solution

2010



Launch of printer scales

2011

Silver Jubilee

2012



Launch of wireless GPS clocks

2013



Launch of India's first Made-in-India POS system

2014



In-house R&D recognised by DSIR, Govt. of India.

2016

Crossed 1 million machine mark

2017



Launch of milk analyser

2020



RDSO
Research Design & Standards Organisation

RDSO certification for GPS clocks

Our Products & Solutions

Electronic Weighing Scale, Balance & System



Weighing System Indicator



Tank Weighing Loadcell & System



Process Weighing Indicator



Crane Scale



Counting Scale

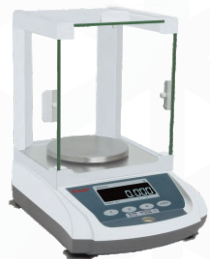

Precision Balance



Analytical Balance



SQC Data Printer



Low-profile Scale



Milk Weigher



Barcode Label Printer Scale



Receipt Printer Scale



Portable Scale

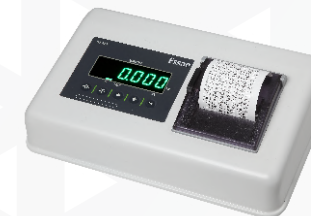

Weighing Scale w/ Printer



Hanging Scale

POS System



Touch Screen POS System



POS Receipt Printer



Cash Drawer



Customer Display



Magnetic Stripe Reader



Embedded OS

Milk Analyser



GPS Synchronised Wireless Clock



Engineering & Automotive

India is one of the leading manufacturers of engineering and automotive products & components for the global market. Essae offers highly innovative solutions for this industry such as Counting Scale, Barcode Label Printing Scale, Process

Weighing Indicator, Crane Scale, GPS Synchronised Wireless Clocks & a very wide choice of Bench and heavy duty 4-Loadcell Platform scales for weighment at various points inside the manufacturing plant.



System Indicator



Crane Scale



Label Printing Scale



Pharmaceutical

India's robust educational system and huge pool of young scientific talent has laid a strong foundation for cutting-edge research & manufacturing industry for the global pharma market. It is a matter of immense pride that India is one of the largest manufacturer & exporter of many life-saving drugs, vaccines and their core API ingredients.

Essae fully understands the importance of stringent USFDA & CFR compliance for our customers in this industry. We offer a very wide range of aligned solutions such as

Tank Weighing Loadcell System, Weighing System Indicator, Analytical Balance, Statistics Data Printer, Flame-Proof Weighing Indicators, ATEX-certified Loadcells, Low-profile Scales etc. We support our customers with extensive documentation needed for IQ/OQ/PQ qualification.

Apart from weighing solutions, Essae offers a wide range of wireless GPS Synchronised Digital Clocks which assist our customers in audit compliance.



Tank Weighing System



GPS Clock

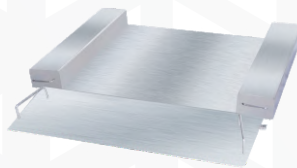

Low-profile Scale



Food Industry

Food is one of the core growth sectors of any economy. Both hygiene & accuracy are vital at all weightment points in this industry. Essae offers an innovative choice of useful weighing solutions for

this ever-green industry. These include a wide range of Tank Weighing solutions, Moisture Analyser, Hanging scale & IP67 Waterproofscale.



Waterproof Scale



Tank Weighing System



Moisture Analyser



Dairy

Thanks to our huge agricultural base and an extremely world-renowned and efficient co-operative system of milk collection from farmers even in the remotest of villages, India is one of the largest producer of milk in the world. The scale & complexity of this industry is indeed remarkable and necessitates the use of the most

modern IoT-enabled technology for ensuring the highest operational efficiency. Essae offers a truly Design & Made-in-India Ultrasonic Milk Analyser & IoT-enabled Weighing scales for use in collection point as well as bulk Milk Weighers at chilling centres and production.



Milk Analyser



Milk Weigher



Weighing Scale



Grocery & Retail

With a large share of young population, India is one of the fastest growing retail & food markets in the world. Due to a fast-paced economy, customer convenience and efficiency of service is mandatory for success for any retailer. Connected technology solutions play a huge role in achieving this objective and gaining market share.

Essae offers smart IoT solutions for this industry such as Receipt Printing Scale, Barcode Label Printing Scale,

Counter Scales, Counting Scale, Windows & Android connectivity software and a very wide choice of Table-Top, Bench & Platform scales for weighment at various points.

The Point-of-Sale (POS) counter is of utmost importance to any retailer in ensuring an accurate, speedy & convenient checkout. Essae offers a wide range of touch screen-based POS Systems, ECR & other useful accessories like Receipt Printer, Cash Drawer, Customer Display etc.



Barcode Label Printer Scale



Receipt Printer Scale



POS System



Food & Beverage

Food & Beverage outlets need to be highly efficient and customer focused in the quality of the products & services they offer to their customers. As competition is extremely fierce in this industry, technology plays a huge role in

enabling superior customer service. Apart from highly elegant and stylish Counter Scales, Essae offers a wide choice of touch screen-based POS Systems, ECR & useful accessories like Receipt Printer, Kitchen Printer, Cash Drawer, Customer Display etc.



Counter Scale



POS System



Printer



Jewellery & Banking

Due to a rich cultural heritage, India is the largest consumer of gold & silver in the world. It is also one of the oldest and most mature industries of the economy. Recently, gold loans sanctioned by banks & other financial institutions are also increasingly becoming popular.

Based on the application and precision needed, Essae offers a wide choice of Load cell, Electro-Magnetic & Tuning Fork-based Precision Balances for weighing of silver and gold. These range from a capacity/accuracy ranging from 220g/0.01mg to 40kg/1g.



Gold Balance



Silver Balance

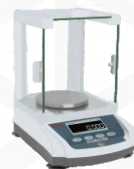

Electro-Magnetic Balance

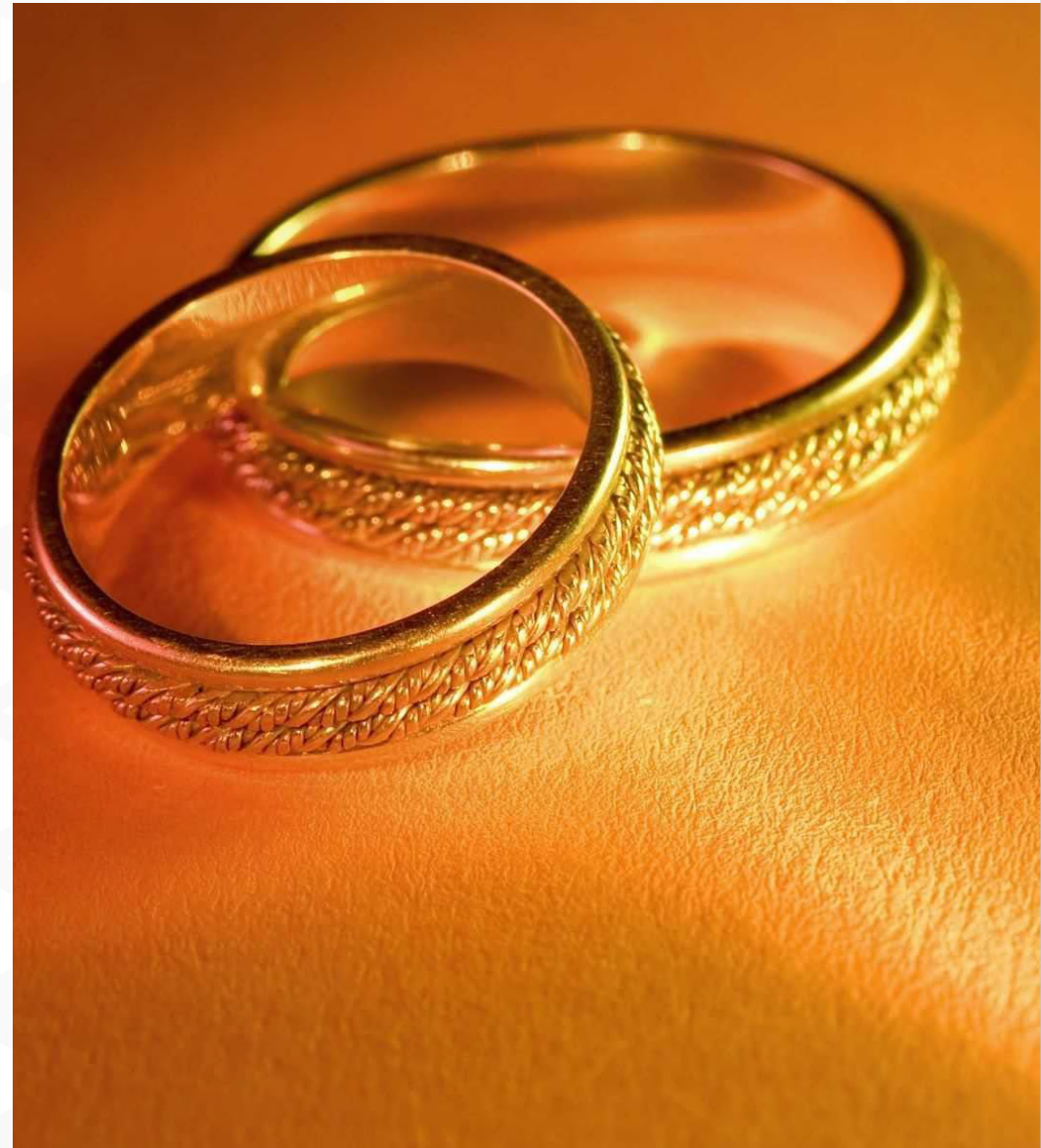

e-Commerce & Logistics

India's vast & remote infrastructure network poses severe challenges for all distribution and logistics operations. With a growing population and increasing share of e-Commerce in modern retail, new customer needs have emerged in this fast-growing industry. Essae

offers unique and smart connected solutions such as Counting Scale, Barcode Label Printing Scale, Portable Scale, Trolley Scale and a wide choice of IoT-enabled Bench & Heavy Duty Platform scales for weighment at various points.



Bluetooth Scale



Platform Scale



Label Printing Scale



Design in India

Every market presents its own challenges and dynamics. From early on, our founder and the senior leadership realised that each market is unique in its maturity and economic structure. Hence globally successful products may or may not succeed here in the domestic market.

Keeping in mind the above objective, Essae continues to invest significantly on growing its in-house Research & Development (R&D) and Engineering infrastructure. Our design team is fully integrated and ably powered by a team of highly qualified engineers in the field of embedded software, high-level application software, electronic circuit & power supply design. Our products are designed, simulated & tested on state-of-the-art 3D CAD design/modelling software, environment chambers and the

latest compilers/development tools. Apart from this, we also work with some of the top industrial designers in Germany & India to enhance the aesthetic appeal of our products. The digital age has made it imperative for all our products be accessible on our customers network. Our products are IoT enabled through various industry standard communication interfaces and protocols such as WiFi, USB, Bluetooth, Modbus, Ethernet IP etc. We provide Windows & Android applications to facilitate seamless communication between our products and the customer data.

Based on a stringent audit process at site, our in-house R&D was recognised in 2014 by the Department of Scientific & Industrial Research, Ministry of Science & Technology, Government of India. Finally, the proof of the above effort lies in many winning flagship

products like Weighing System Indicator, Electro-Magnetic Weighing Balance, Ultrasonic Milk Analyser, Touch Screen POS Systems & Barcode Label Printing Scales. All our models are approved by legal metrology department. We are proud of the fact that Essae is the first and only company currently to be designing and manufacturing the above high-end product solutions in India from concept to mass production.



**AATMA-NIRBHAR
BHARAT**



IoT



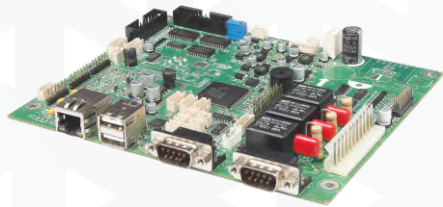

ARM-based Electronic Circuit Board

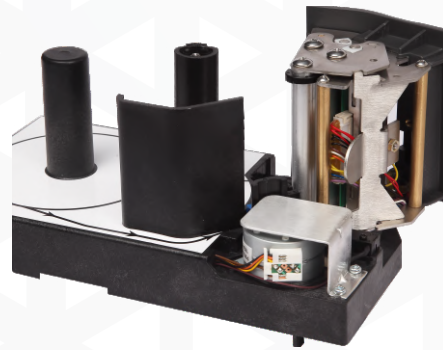

Barcode Label Printing Mechanism

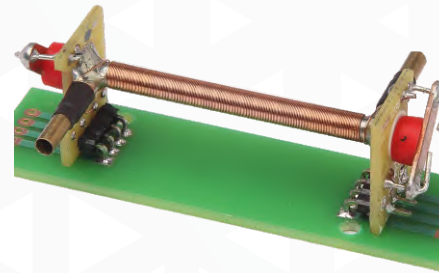

Ultrasonic Milk Analyser Sensor

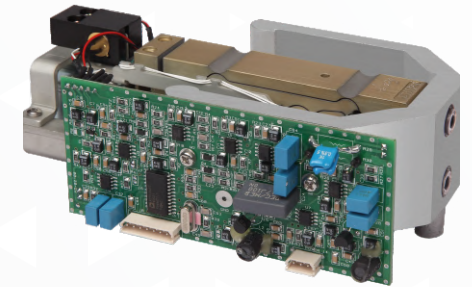

Electro-Magnetic Weighing Sensor

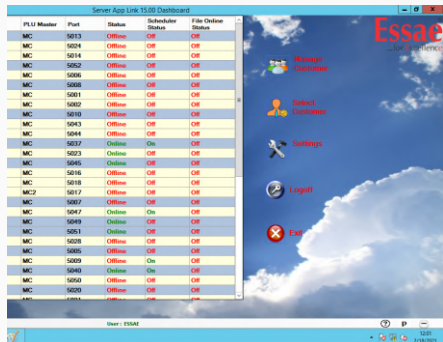

Windows Application

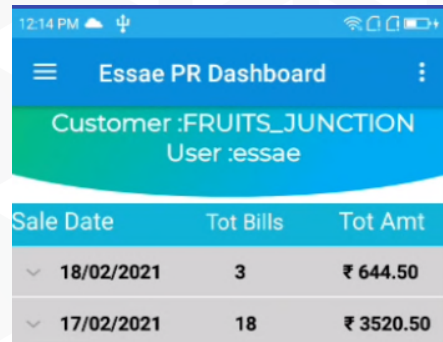

Android App

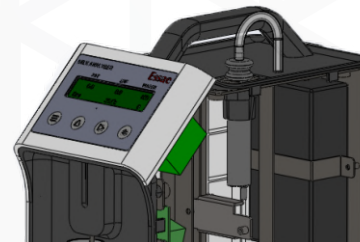

Computer Aided Design

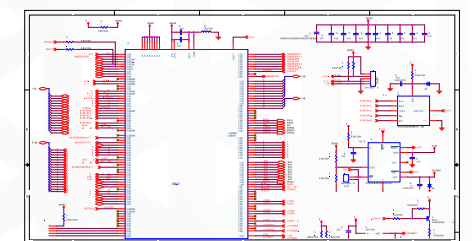

Circuit CAD

Make in India

Our founder had the vision to realise as early as 1986 that no company can succeed in India unless it engages in local design and manufacturing. We started manufacturing our products when all our global competitors were only trading. This was a key success point which gave us an early and unique competitive edge.

Our factories in Bengaluru & Goa are equipped with the latest machinery and modern automation equipment to deliver the highest quality to our customers. We were one of the earliest companies to gain the ISO-9001 certification from BVQI, UK in 1994. We have always upheld the firm conviction that quality has to be built into our design & process rather than through inspection. Our

installation base of over 1 million machines is proof of our sustained excellence in customer-centric quality and service. In line with our vision of digital transformation and process automation, we were one of the earliest companies to invest significantly in state-of-the-art Enterprise Resource Planning (ERP) software. Apart from this, we host our own data centres for ensuring high data security & also have our own in-house technical team for customising our IT & ERP requirements.

This investment continues to pay rich dividends in terms of delivering high quality, competitive value, prompt delivery & efficient service to all our customers & business partners.



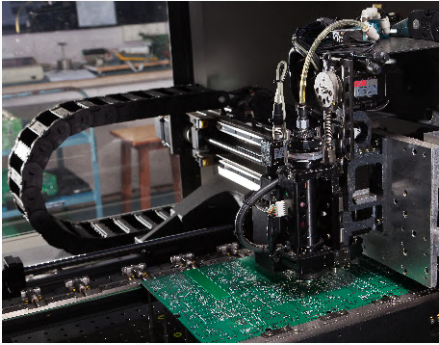

Automatic PCBA Pick & Place

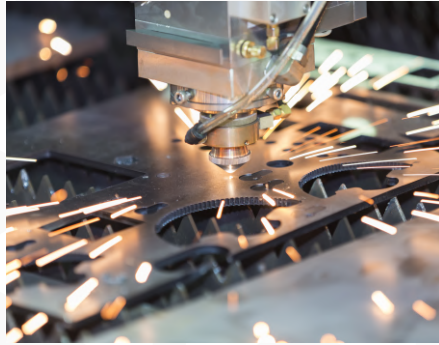

CNC Laser Cutting

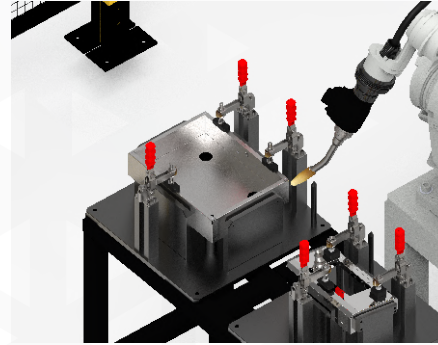

Robotic Welding

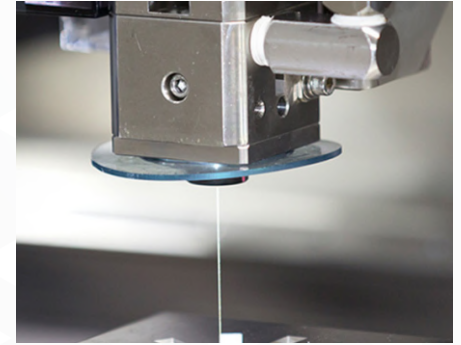

CNC Wire EDM



Environment Chamber

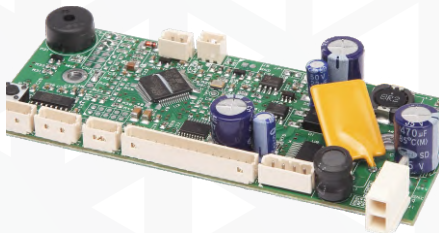

Printer Control PCBA



Deep draw Weldless SS Console

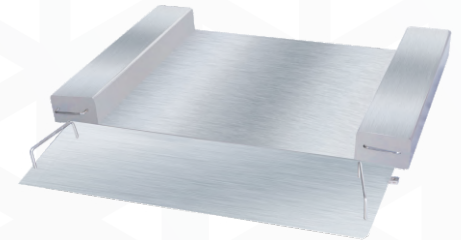

Low-profile Scale Platform

Essae Family, Anywhere Anytime

Large key accounts & global customers operate across the country, including very remote areas where infrastructure and logistics poses a severe challenge. It is imperative for any supply partner of such customers to have a vibrant and agile strong sales & service network, PAN-India.

Essae is proud of its extremely robust and mature nation-wide network of 39 branch offices, ably manned by over 150 sales staff & 180 service engineers. To compliment our own infrastructure, we also partner with over 300 Resellers, System Integrators, ISV & service franchisees. Post warranty, we offer our customers a wide variety of options for entering into a comprehensive annual service

contract (ASC) with us. This ensures un-interrupted support and smooth operations for the entire life cycle of the product. In line with our overall vision of digital transformation, our after-sales support operations are powered by a robust CRM platform. This enables us to monitor and review our on-time performance and also provide useful Data Analytics.

All the above factors ensure a unique competitive advantage to offer the highest quality of both pre-sales and post-sales technical support for our customers.



HQ and R&D
Bengaluru



Sharing...

"To whom much is given, much is expected" - John F Kennedy

In line with our vision statement of sharing wealth & wisdom with all stakeholders, the Essae Foundation of Janani Trust was formed in the year 2000, much before corporate CSR was made mandatory by the Government in 2014. So far, the foundation has adopted 13 deserving schools and contributed more than Rs. 12 crore since inception for various causes covered under the broad objectives of the

trust. Some of the projects include mid-day meals, uniform, softskills training for both students & teacher training, club foot program, All India Movement (AIM) for Seva and any cause furthering the progress of primary education for the deserving. The foundation also supports the teaching of our ancient spiritual wisdom.

The volunteers, time & money come largely from the corporate surplus.

Vision

Share the wisdom and wealth for the welfare of external and internal customers, business associates and society at large



motto Essae Foundation
of Janani Trust

विद्यया विन्दते अमृतम्
Vidyaya vindate amrtam
ವಿದ್ಯಯಾ ವಿಂದತೇ ಅಮೃತಂ

Through Knowledge, one attains Bliss (Happiness)





Essae-Teraoka Pvt. Ltd.
1-800-425-3111
www.essae.com